



Brief Introduction on HOM Nest System

Beijing HOM Agri. & Tech. Development Co., Ltd.
www.HOM.net.cn



Brief Introduction on Mechanical Nest System

Both Sides Individual Mechanical Nest System



The Collection Table Designed for Easy Operation





Existing view In Chicken House



Some Patents for Mechanical Nest System

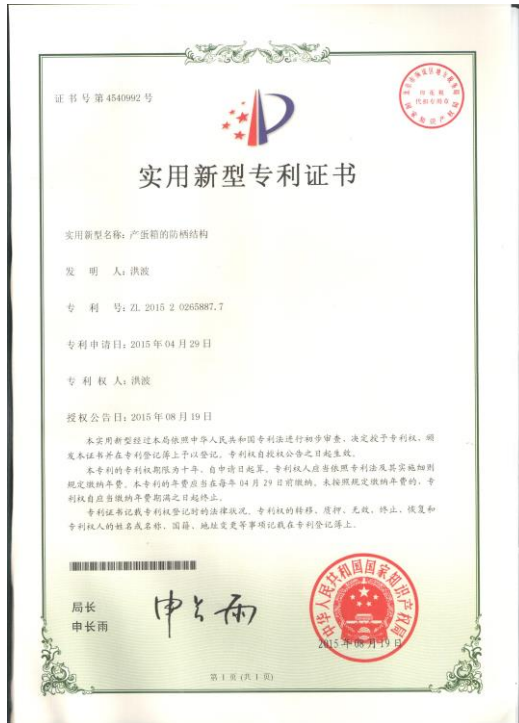

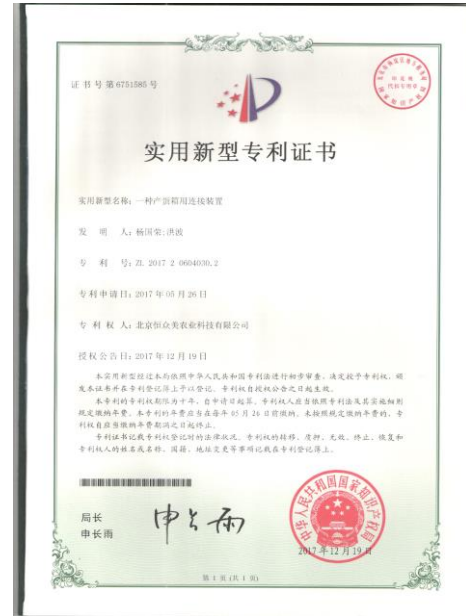
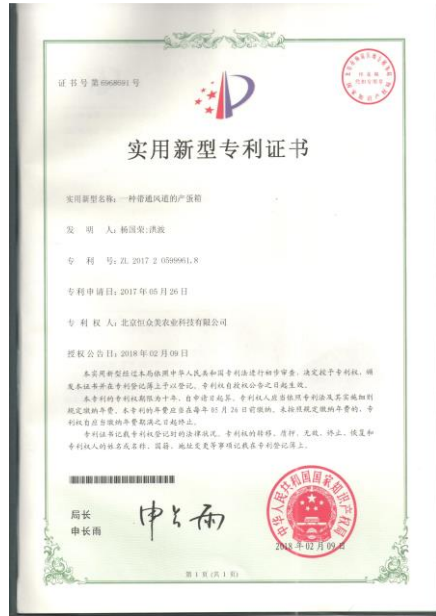
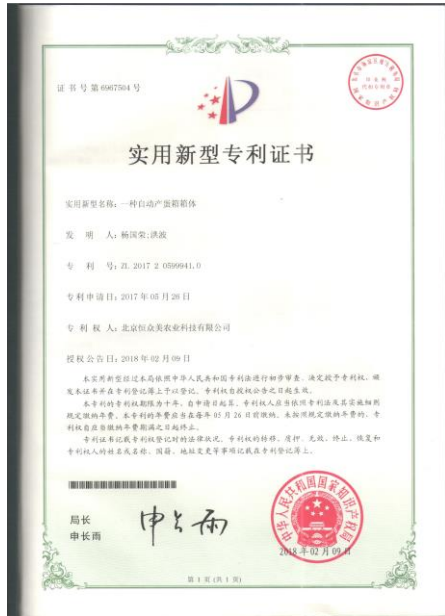

Advantage of Machanical Nest System

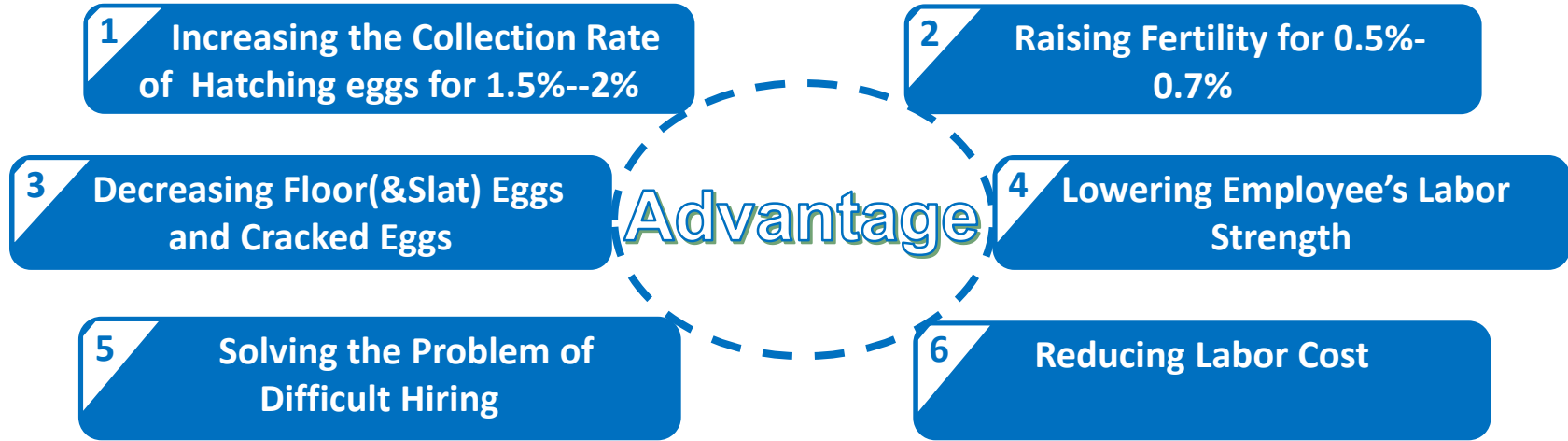

Collection Rate of Eggs

Actual Egg Production %

Record Egg Production % **Lost %**

||

Collection Rate of Eggs = Actual Egg Production % - **Lost %**



02

The Cases and Data

Representative customers of GP Farms

- ★

Beijing Arbor Acres Poultry Breeding Co.,Ltd
- ★

Beijing DaFaun Poultry Breeding Co.,Ltd
- ★

Cobb (Hubei) Breeding Co.,Ltd
- ★

Zhucheng Waimao Co., Ltd
- ★

Haimen Jinghai Meat-Chicken Group Company
- ★

Hebei Feilong Fowl Breeding co., Ltd

Representative customers of PS Farms

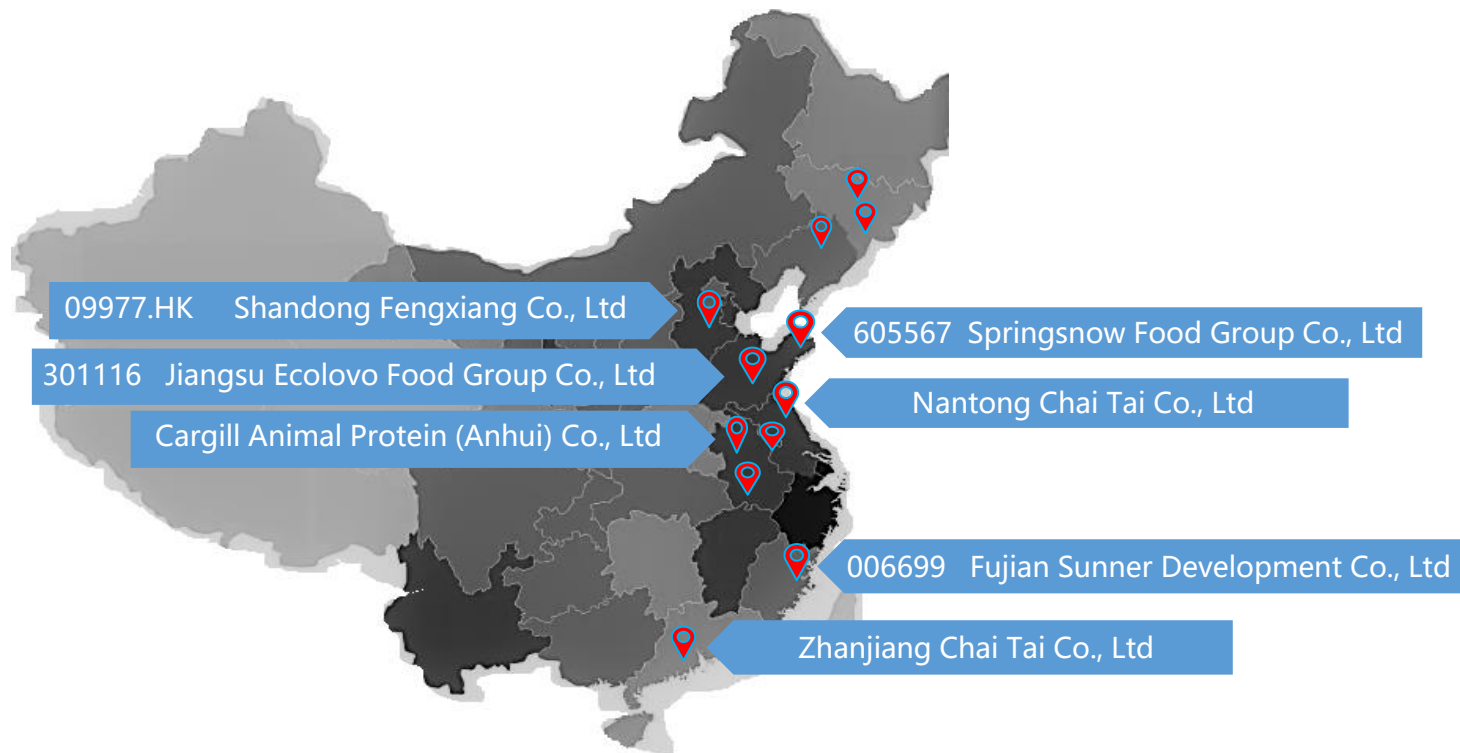

Case No. 1 (Year 2013) :

Duolun **Broiler** GP Farm of Beijing Dafaun Co. 8 Houses of 126X13M. Among them 4 Houses have used HOM Nest System.



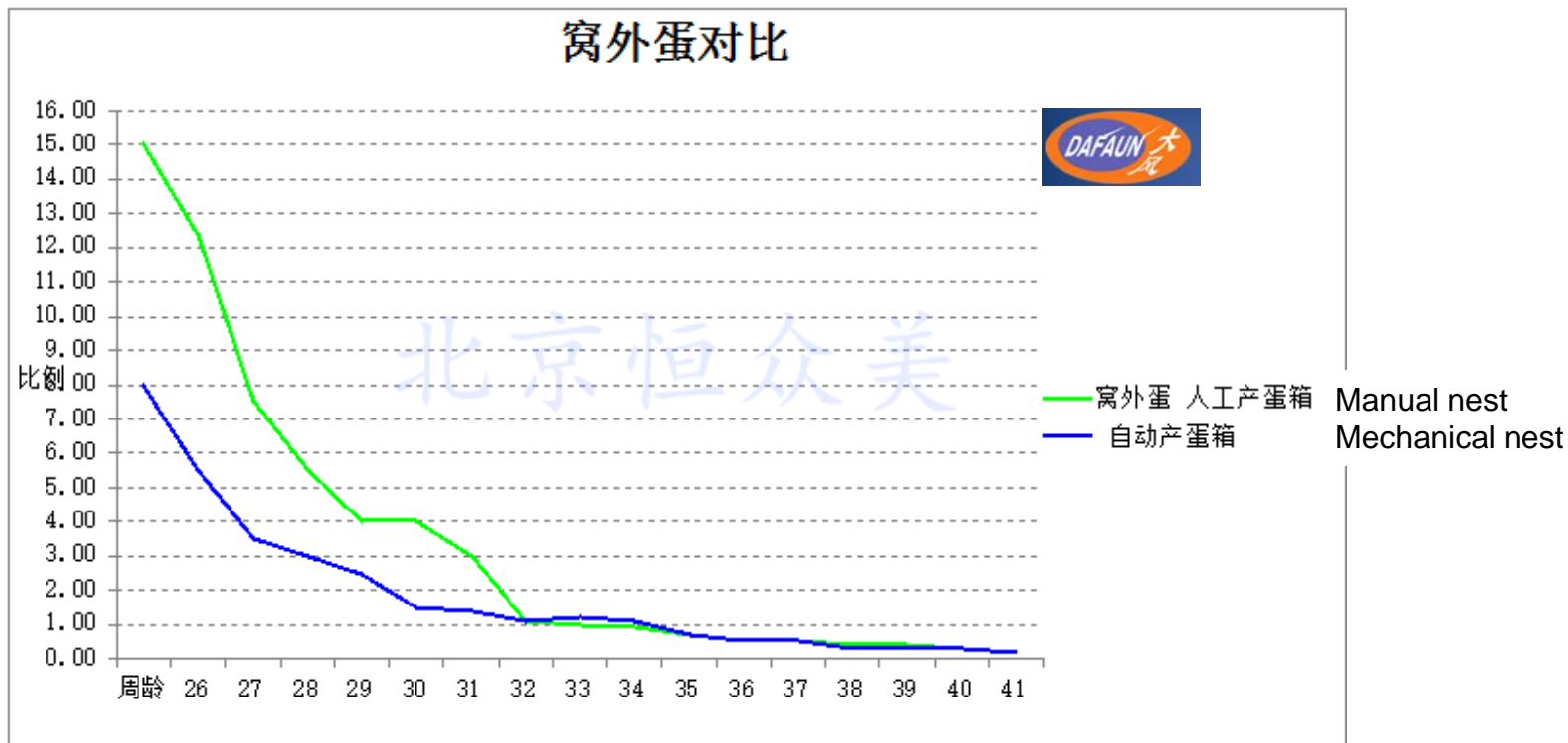

Non-nest eggs between mechanical & manual nest system

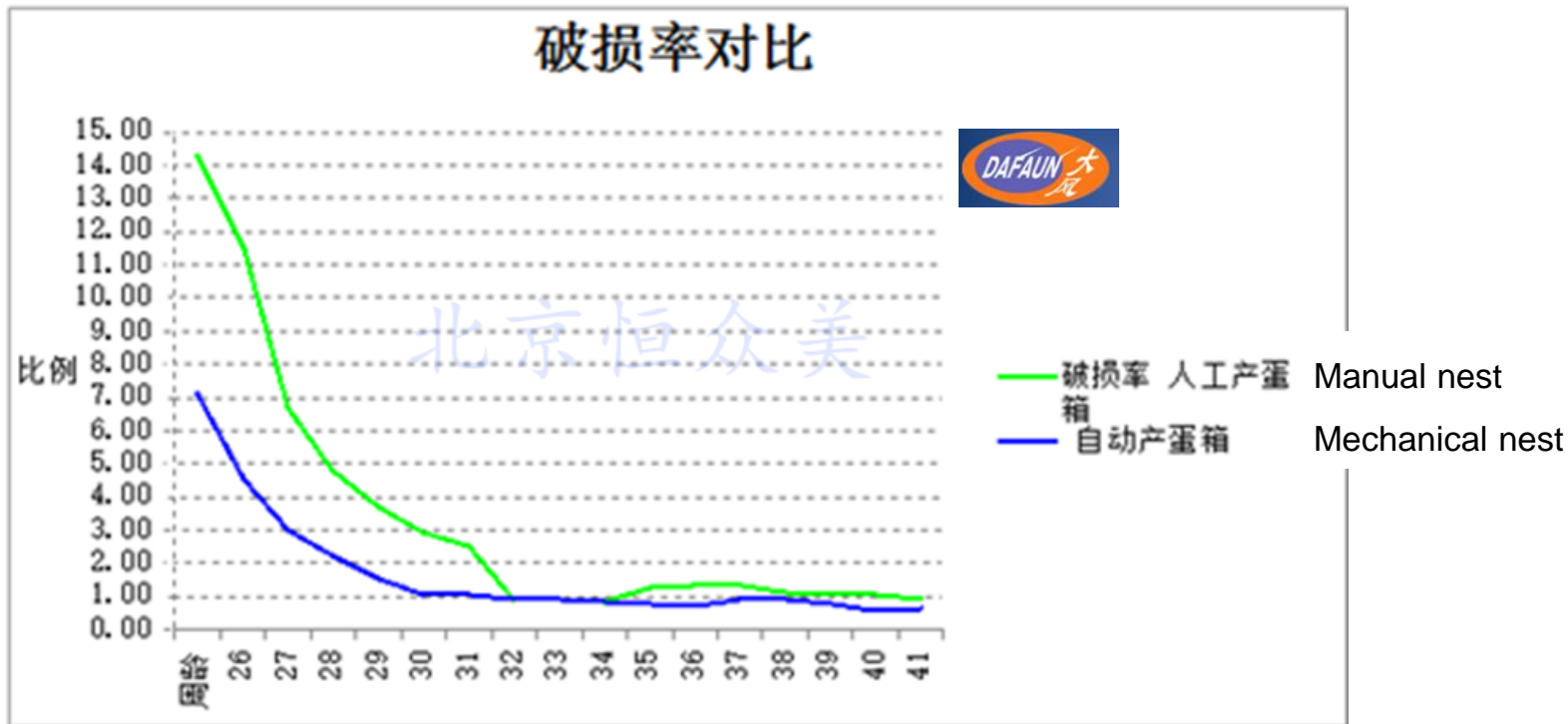

Cracked eggs ratio between mechanical & manual nest system

Case No. 2 (Year 2013) :

Zhoukou **Broiler** PS Farm of Henan Dayong Co. 2 Houses have used HOM Nest System among 6 Houses of 100x24M.



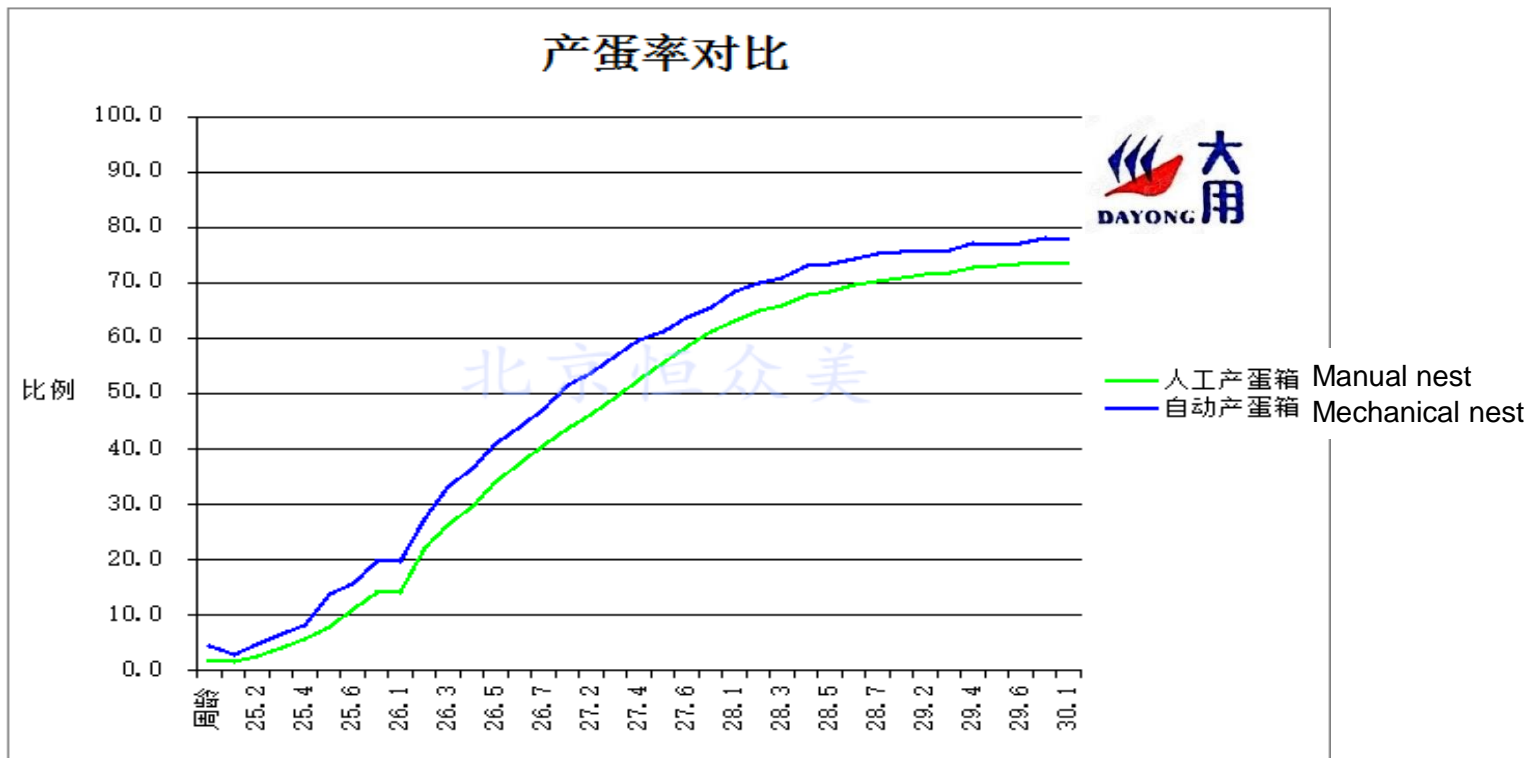

Egg production between mechanical & manual nest system

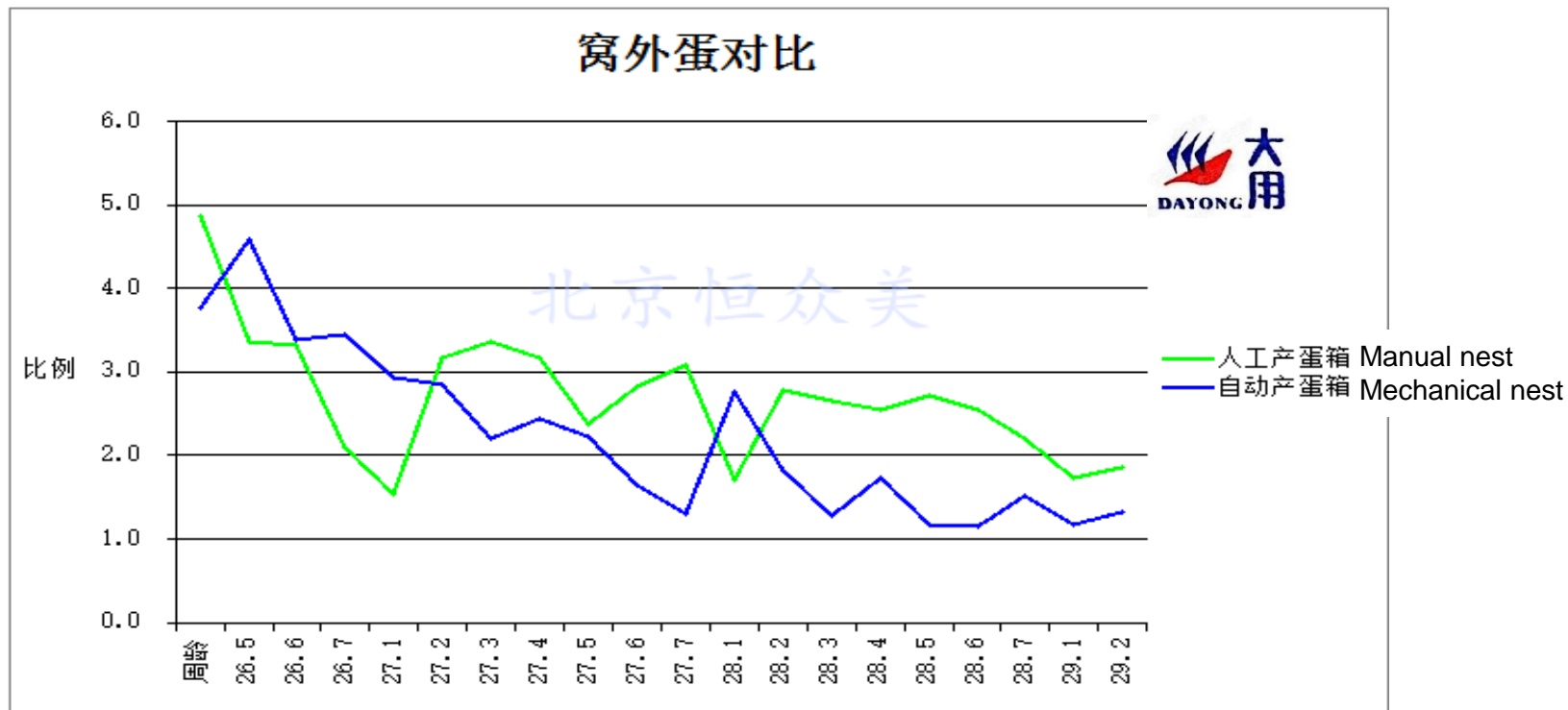

Non-nest eggs between mechanical & manual nest system

Case No. 4 (Year 2015) :

Gaomi **Broiler** PS Farm of Qingdao Kangda Co. 8 Houses of 116x12M. Among them one house for HOM, and one house for competitor. The rests are manual systems



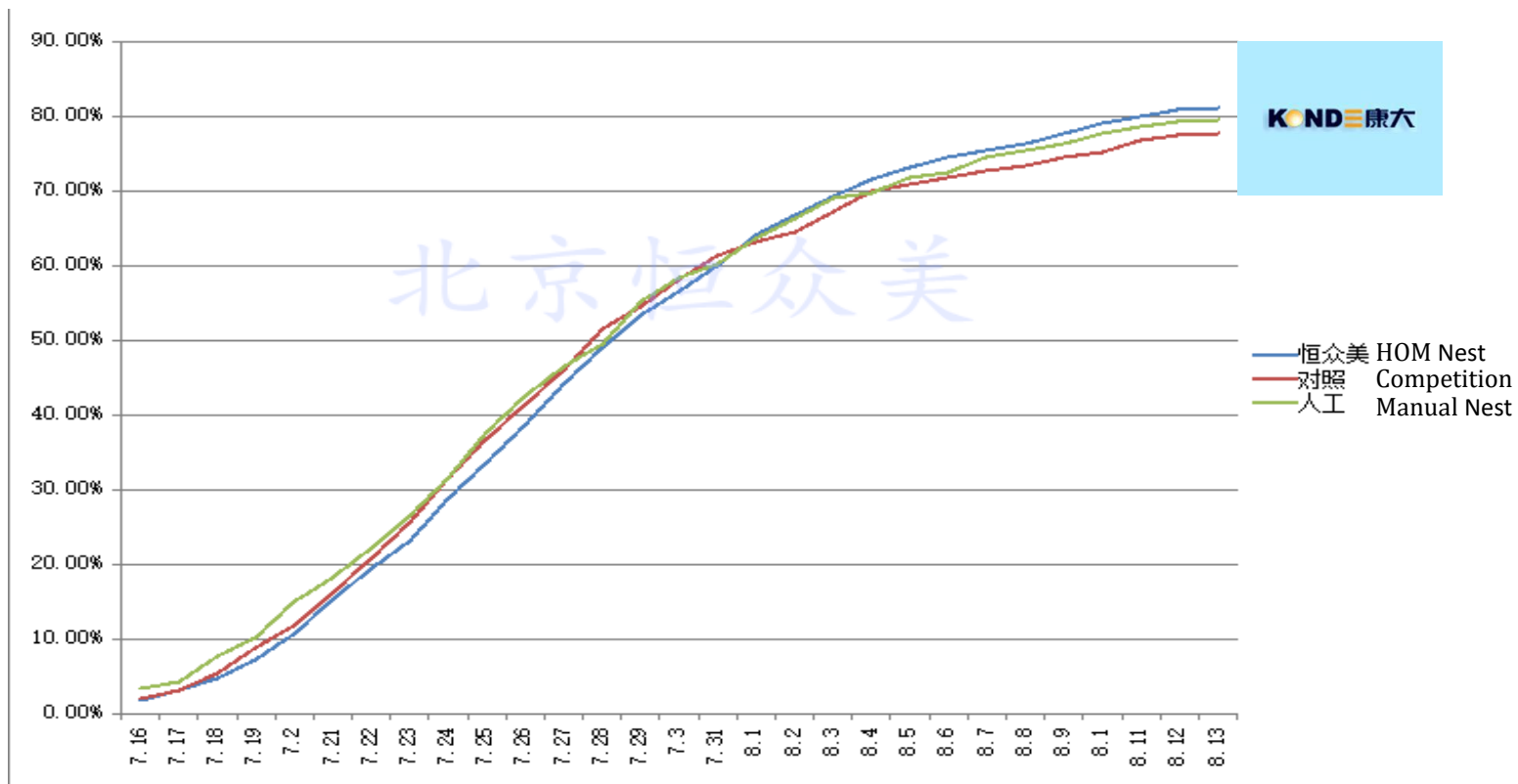

Egg production between mechanical & manual nest system

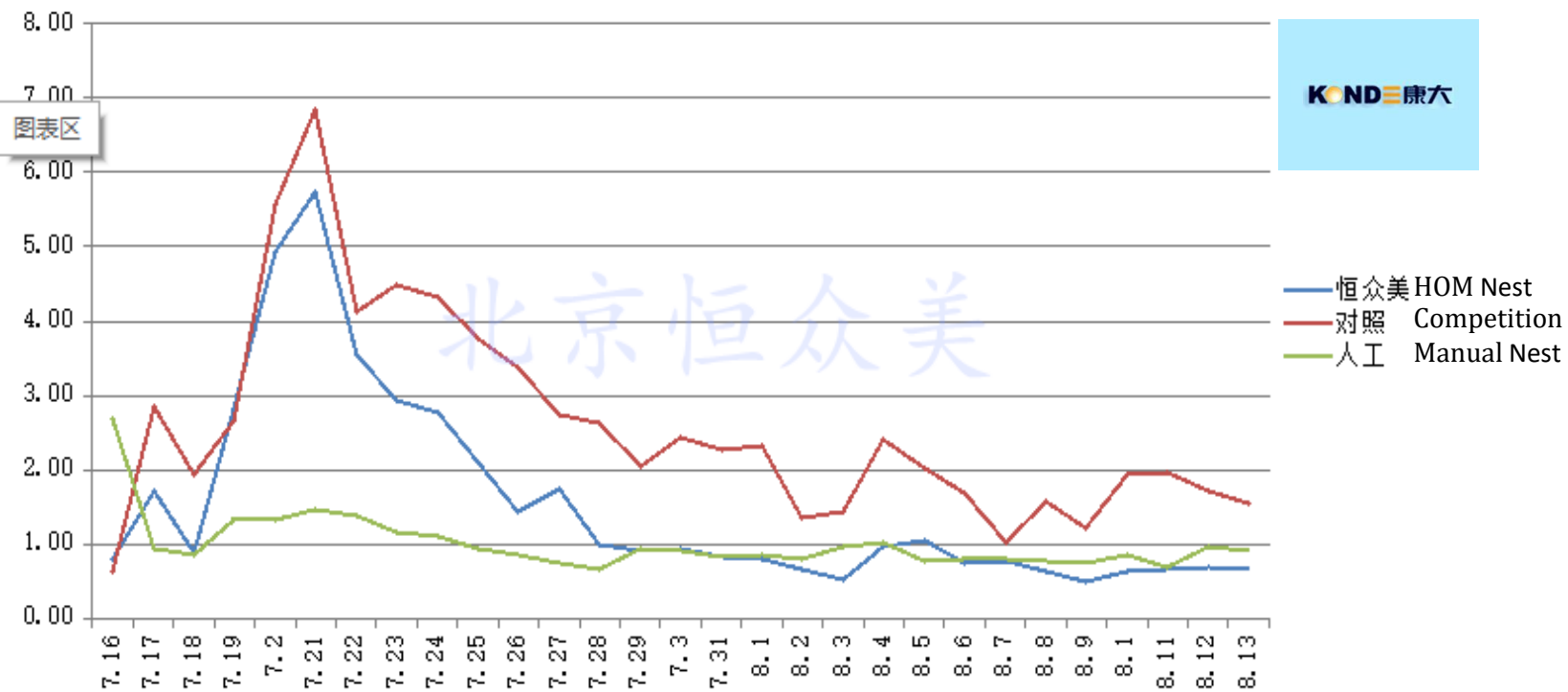

Non-nest eggs between mechanical & manual nest system

Case No. 5 (Year 2015) :

Fengxiang **Broiler** PS Farm of GMK Group Co. 8 Houses of 120x13.5M. One house with HOM Nest system, the others with Manual system



Case No. 6 (Year 2017) :

Broiler PS Farm of Shandong Yatai Zhonghui Co. 9 Houses of 112x12M. Among them 3 houses with HOM nest, 3 houses with Competitor B and the others with Competitor Z



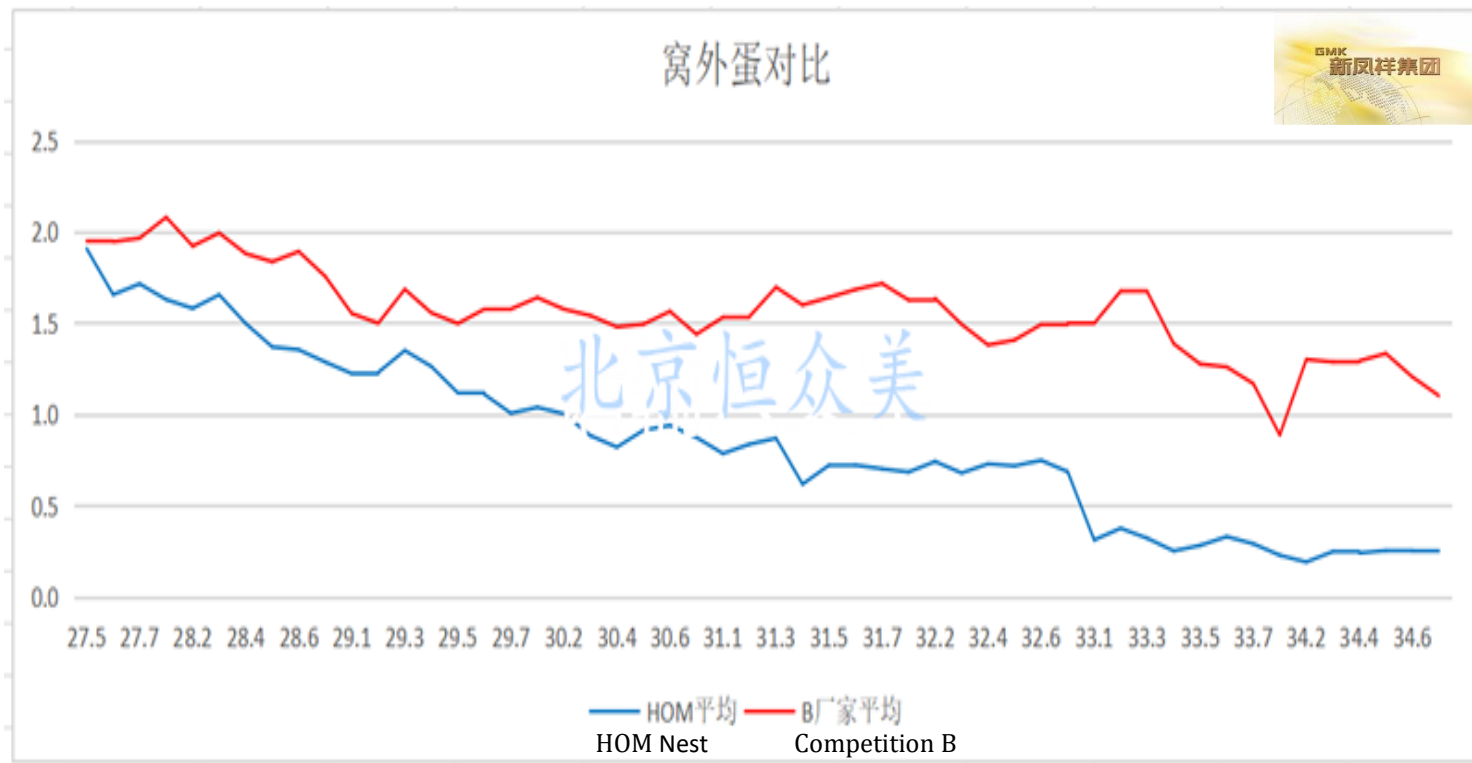

Non-nest eggs ratio between mechanical & manual nest system

Case No. 7:

Nantong Sub-Co. of CP Group China, Year2018, 4 Houses (108X13.5m) with HOM System, compared to Chore-time' s system.



Case No. 8:

Chuzhou **Broiler** PS Farm of US Cargill Co. Year 2018, Among 8 Houses (118X14米), 2 houses used HOM compared to BD、GSI and Competitor D



Crack eggs in Cobb PS farm hatchery (Average for 6weeks)

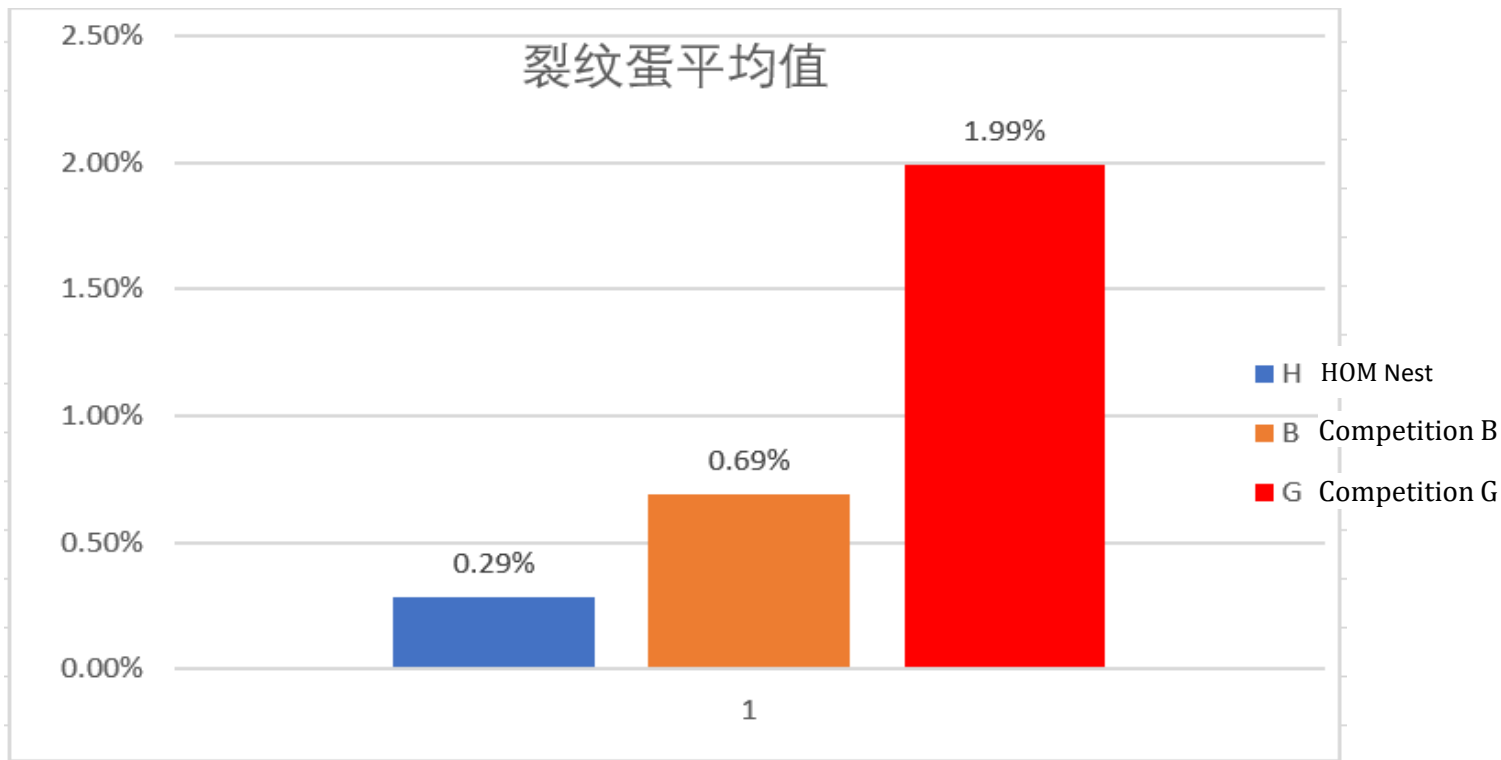



03

The Advantage of HOM Mechanical Nest System

1. The Frame Construction Is Strong enough to Guarantee for 10 Years in Normal Case

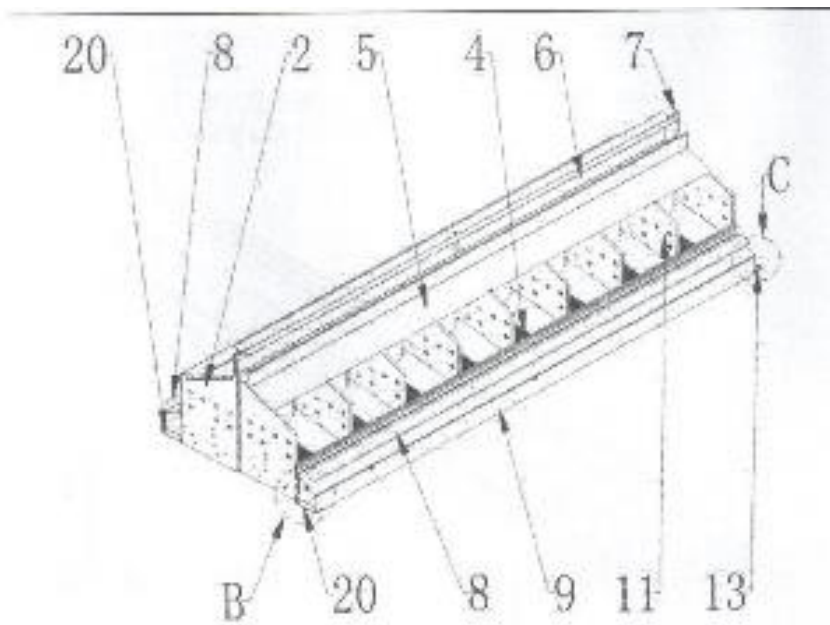

2. Using Electrical Components of Top Brand in The World, Imported 3-Phase Motor, More Stable and Low Failure

ABB变频器



施耐德电器



进口专用变频电机



3. All Parts Contacting with Eggs Come from The Europe Original, Less Breakage of Eggs



4. Stainless Steel Screws, Rivets and Jam Nuts Have Been Completely Adopted, Ensure More Solid Build



5. Reserved The System Promotion Interface, and Easier to Achieve The Objective Handling Eggs Automatically in Whole Farm

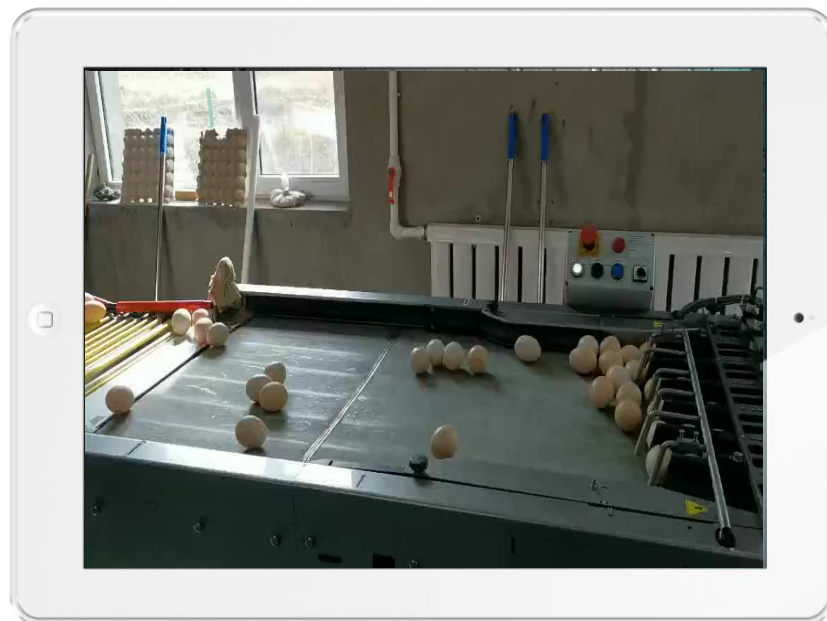
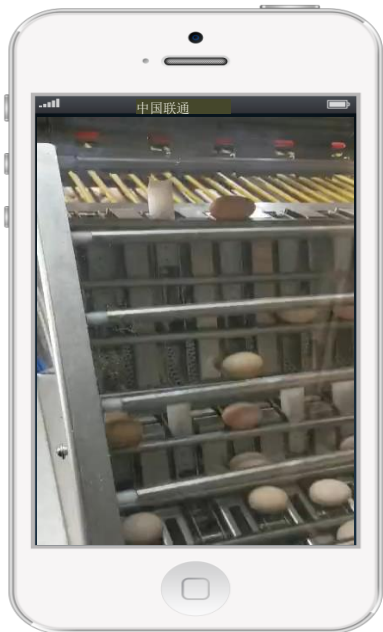
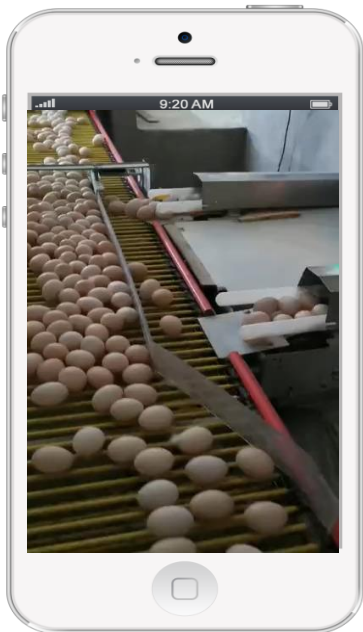

6. A Patented System with Rapid Dismounting/Assembling structure, Perfect for Old Chicken House

(19) 中华人民共和国国家知识产权局

(12) 实用新型专利

(10) 授权公告号 CN 204560585 U
(45) 授权公告日 2015.08.19

(21) 申请号 201520265750.1
(22) 申请日 2015.04.29
(73) 专利权人 洪波
地址 100085 北京市海淀区安宁庄西三条9号1幢2单元215室
(72) 发明人 洪波
(74) 专利代理机构 北京中誉威圣知识产权代理有限公司 11279
代理人 蒋常雪

(51) Int. Cl.
A01K 31/16(2006.01)

权利要求书1页 说明书7页 附图6页

(54) 实用新型名称

可拆卸的单体式两侧集蛋自动产蛋箱

(57) 摘要

可拆卸的单体式两侧集蛋自动产蛋箱,由若干个蛋箱组通过过道串联构成,每个蛋箱组为1个箱体或2个箱体的组合结构,箱体的左右侧面分别设有一个箱体蛋槽,所述箱体蛋槽与每个产蛋室连通来收集鸡蛋;蛋箱组内相邻的两个箱体之间通过箱体连接结构可拆卸连接;所述过道与蛋箱组的箱体蛋槽通过拆卸连接结构可拆卸连接。本实用新型通过拆卸连接结构和箱体连接结构,将箱体与箱体之间、箱体与过道之间可拆卸连

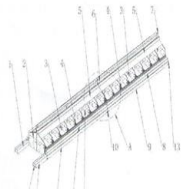

CN 204560585 U 说明书附图 3/6页

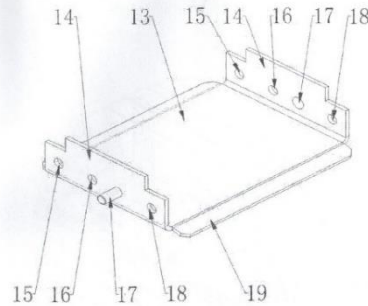

图4

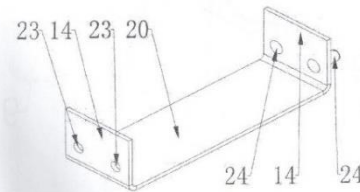

图5